



VACUREMA®

Inline Applications

Food Contact Approved

CHOOSE THE NUMBER ONE.

EREMA® 
PLASTIC RECYCLING SYSTEMS

The best way is the direct way

There is a way which takes you to your target faster. Without detours. A way which enables you to save energy and space, increase your productivity and reduce your costs. **It is the direct way: the VACUREMA® Inline solution.** With this solution you go from post-consumer PET flakes directly to finished thermoforming sheet or bottle preforms, to finished strapping or monofilaments. In a single process step.

We achieve these direct benefits for you by combining the highly efficient VACUREMA® system with the appropriate downstream production line. Leading technologies which merge seamlessly. **For more efficiency and profitability from your production facility.**

Better solution. Better direct.
VACUREMA® Inline Applications.

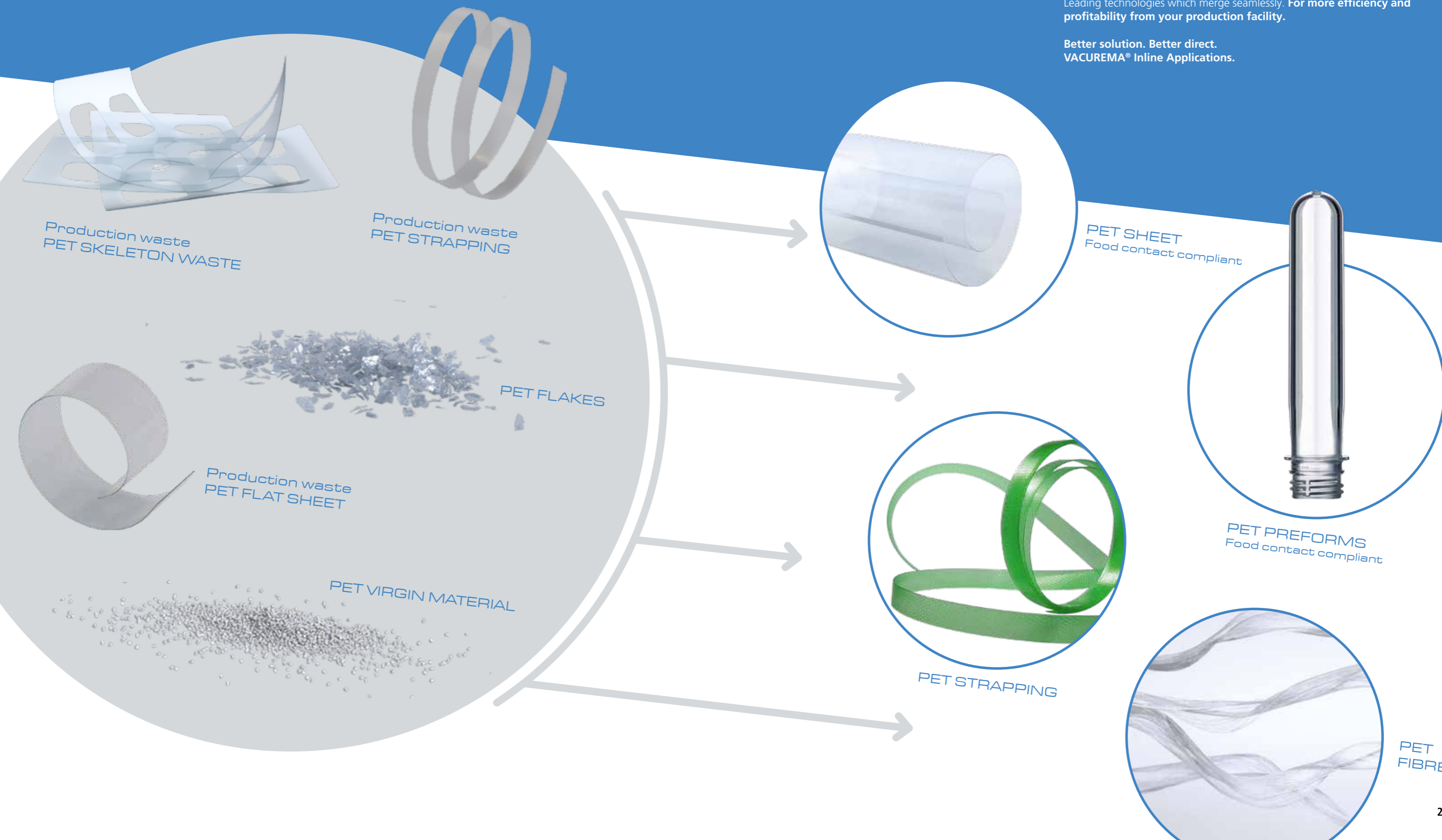

VACUREMA® Inline Applications

In line with your objectives:

- **High profitability and production efficiency:** end products directly from post-consumer PET flakes, in a single process step, without the detour via pellet production
- **Extremely clean, top products,** approved for direct food contact
- **Flexible on input, stable on output:**
Broad range of PET input materials possible: bottle flakes, ground amorphous skeleton waste, edge trim, strapping production waste, virgin material, bulk densities from 250 to 850 kg/m³
Output: consistent end products in terms of IV value and colour despite varying moisture, IV values and bulk densities in the input material
- **Maximum resource efficiency:** technology saves energy, logistics, water and space
- **Easy to operate,** high degree of automation

VACUREMA® = 1 closed complete system:

All functions, such as predrying and decontamination in the reactor, extrusion and filtration flow seamlessly into each other without interruptions (so no malfunction-sensitive conveyance/gravimetry is necessary – unlike other systems)

Everything from a single source: all VACUREMA® core components such as the reactor, extruder or filter come from the EREMA Group

• Reliable and proven:

Overall VACUREMA® capacity worldwide:
more than 1.2 million tonnes of rPET per year

Collaboration with **the leading manufacturers of downstream equipment**



VACUREMA®
INLINE APPLICATIONS



BETTER SOLUTION.
BETTER DIRECT.



One step ahead

VACUREMA® removes migration substances and moisture already BEFORE extrusion

One of the key benefits of the patented VACUREMA® technology is that decontamination and the removal of moisture already takes place BEFORE extrusion. This is a clear bonus for the quality of the melt and, as a result, of your end product. Because you receive a very IV-stable product with top mechanical properties. Precisely what you need for your thermoforming sheet, bottle preforms, strapping or monofilaments.

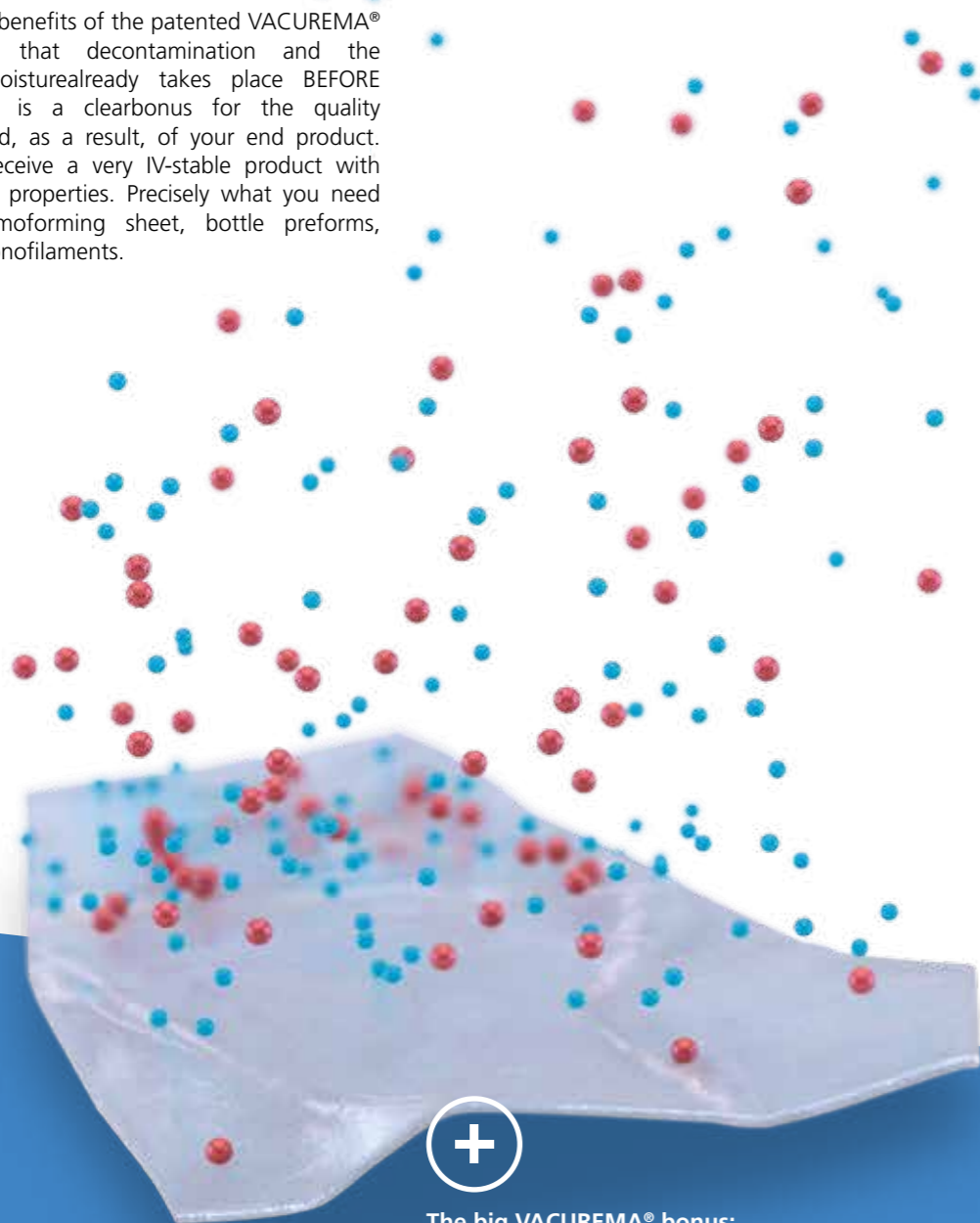

The big VACUREMA® bonus: Moisture and harmful chemical contaminants are removed effectively from the PET flakes BEFORE extrusion.

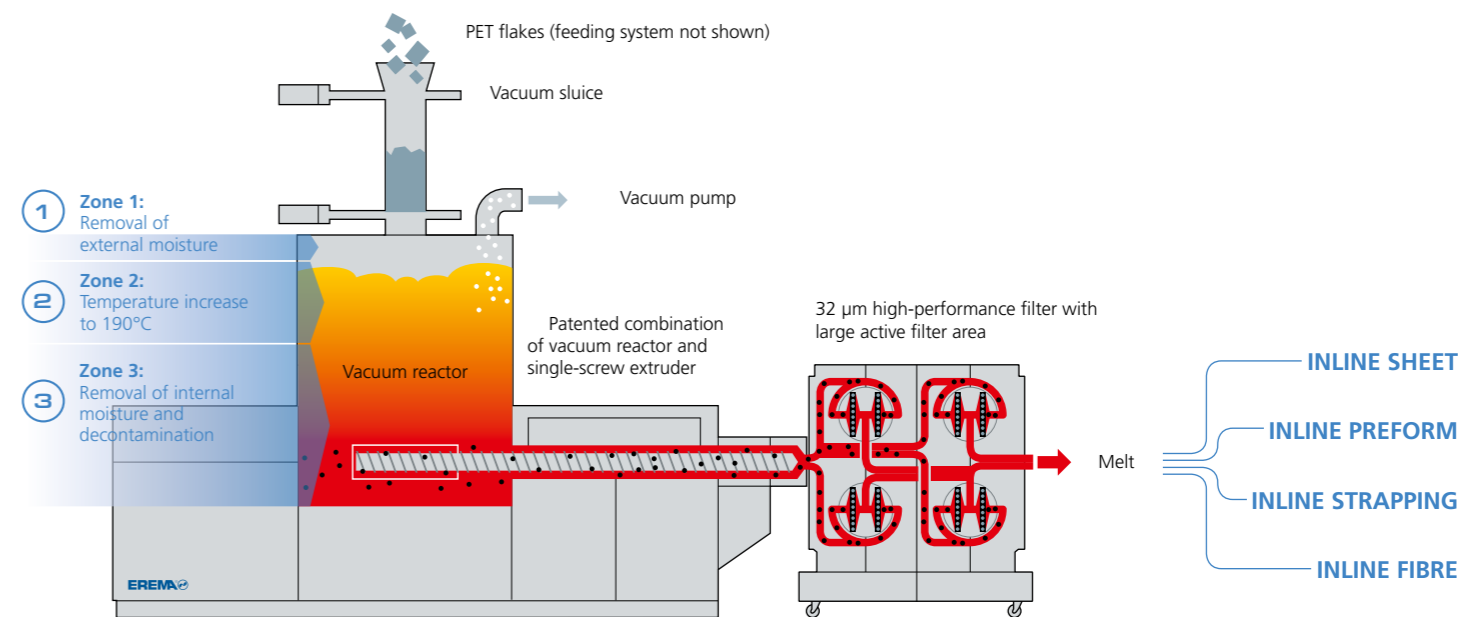

From flakes to the end product in a single process step. How it works:

The key components of the system include a vacuum reactor which is connected directly to a single-screw extruder. Thanks to the ingenious function of the mixers in the vacuum reactor they feature **three ultra-efficient function zones** which interact perfectly with each other to decontaminate and predry the PET material perfectly already BEFORE extrusion:

Zone 1 is responsible for the removal of the outer moisture of the PET flakes. The amorphous, washed flakes which enter Zone 1 via a vacuum sluice still have extremely varying external moisture (between 0.5 and 1%). This is eliminated at around 20°C under vacuum through the reduced vaporisation point (the inner moisture here is still constant at around 0.3%).

In Zone 2 the temperature rises from 20°C to 190°C. Thanks to the constantly rising temperature the polymer structure opens up and the process for the removal of the migration substances and the internal moisture from the flakes begins.

Zone 3: The flake decontamination and removal process unfolds with full effect. The material moves layer by layer in the direction of the single-screw extruder during the exactly defined residence time. With very low residual moisture of under 0.05% the clean, perfectly prepared material enters the intake zone of the extruder.

This material transfer takes place under high vacuum. As a result, no additional degassing ports are required on the extruder. This means that VACUREMA® technology drastically reduces the length of the extruder, lowers its energy consumption, improves the colour values (b value) of the processed material and keeps AA values to a very low level. Moreover, the strong homogenisation performance of the extruder plays a significant part in turning the different input IV values into a stable output IV value.

In the downstream **large-area high-performance fine filter** the material is filtered with a 32 µm mesh screen width. The filter system is equipped with a patented fully automatic self-cleaning system that enables long filter service life.

The melt is now ready and can be transferred directly to the downstream unit. This is where the desired end products – thermoforming sheet, preforms, strapping or fibres – are produced inline **without the detour of pelletising**.

As an option, amorphous or crystalline pellets can also be produced instead of the end products.

Multifunctional vacuum reactor The functions at a glance:

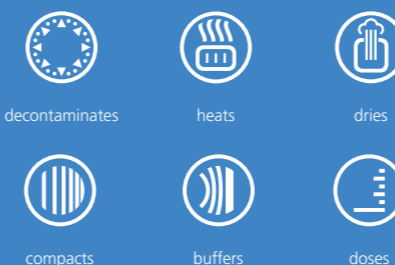

Food contact compliant. Safe and sound.

No compromises when it comes to direct food contact. Trust in the most proven technology. Trust in: VACUREMA®. With regard to food contact compliance it is once again the basic VACUREMA® principle which ensures reliability because, as the flakes are already decontaminated, any undesired migration substances are removed before extrusion. This means that the materials removed cannot make their way into the polymer either.

As a result, you have extremely clean products which are approved for direct food contact. Plus: these products fulfil the criteria of the EFSA, major brand owners and a globally recognized North American food safety authority.

Process stability and traceability through Food Contact Control (FCC)

The parameters for direct food contact compliance are monitored and saved continuously throughout the recycling process. This is handled by the automatic operation mode FCC – Food Contact Control. If levels are not kept, an alarm is triggered automatically and optionally material flow is diverted away from the production line. Data traceability is also guaranteed thanks to archiving with FCC. The result is a reliable process at all times.

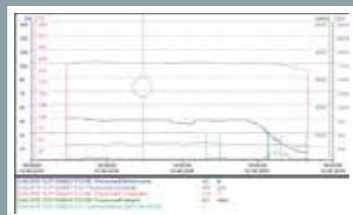

VACUREMA® Country approvals (selection)

BRAND
OWNER
APPROVED



... AND MANY MORE

Food contact compliance with VACUREMA®:
Technology well within the strict EFSA thresholds

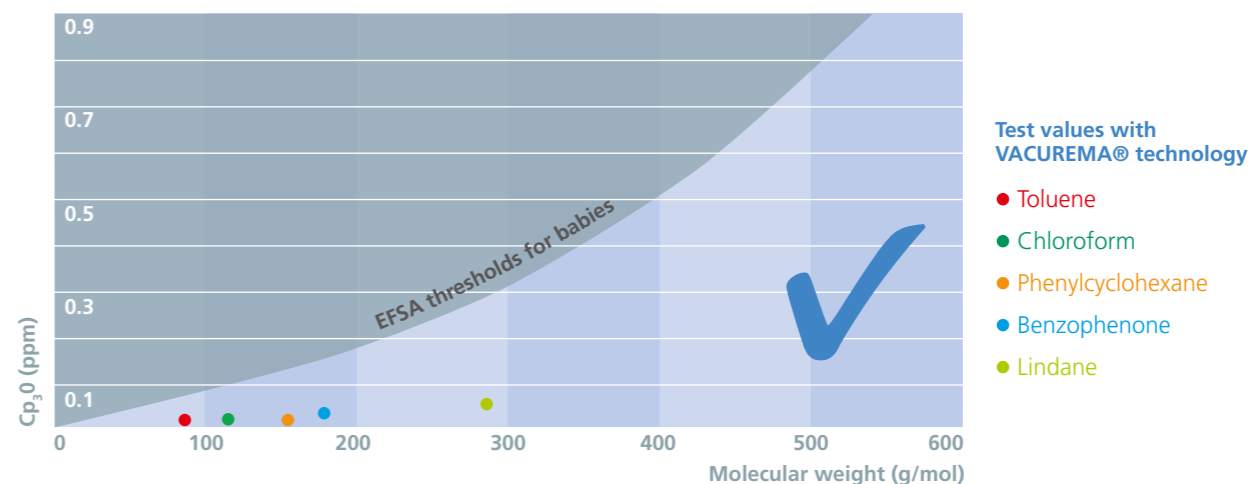

The inner values are exemplary.

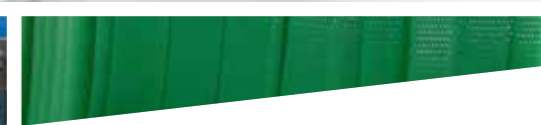

High IV values, superior stability

Intrinsic viscosity (IV) is one of the central quality criteria in rPET processing. This is because it has a significant impact on the mechanical properties of the end product in terms of tensile strength or stiffness, for example. These play a key role in the trouble-free further processing of preforms in the subsequent stretch-blow process or in the thermoforming process with rPET sheet. The right intrinsic viscosity is important for strapping so it has a high strength and is resistant to splicing.

This means, therefore, that the PET recycling system has to reach the exact IV value which is required for the respective bottle application. And: also keep this value constant at the defined level. In other words: maximum process stability.

VACUREMA®: stable IV values like virgin material

VACUREMA® technology fulfils this requirement to perfection. And gives you rPET melt with outstanding IV stability. The intrinsic viscosity is so stable here that the values even lie within the tolerance thresholds for virgin PET material. Besides high product stability, this means that virgin material can be replaced with rPET.

IV stability thanks to vacuum treatment and homogenisation

The high IV stability is achieved here through the patented vacuum pretreatment of the flakes prior to extrusion (reduction of bulk density range) in combination with the high homogenisation performance in the extruder. Major differences in the input material, such as varying moisture or varying mixtures of PET flakes and PET production waste (sheet, skeleton waste, strapping, etc.) with different wall thicknesses and IV values are thus evened out and turned into a stable and homogeneous state.

Quality control: IV values in real time

Thanks to the practical online viscometer, you are informed about the current IV value at all times during the ongoing process. This continuous online IV measurement, combined with the fully automatic facility control system, enables you to influence a number of important processing parameters such as throughput, processing temperatures, filling levels, etc.

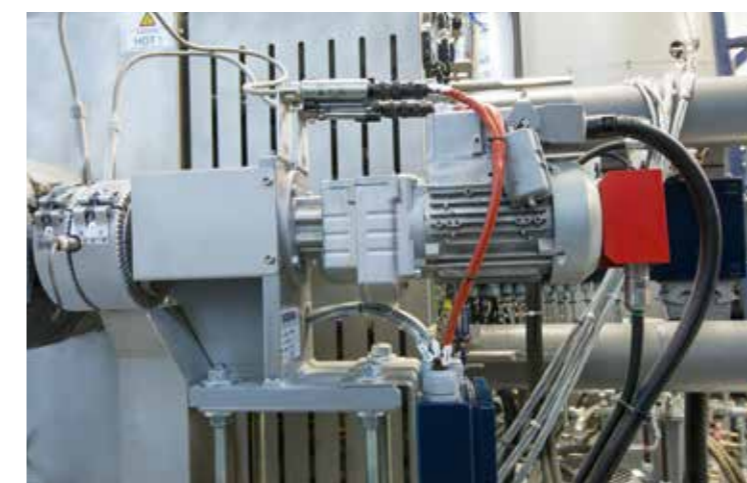

INPUT IV – TYPICAL DISTRIBUTION

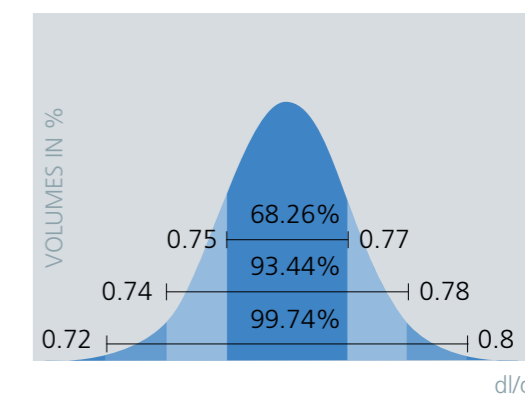

OUTPUT IV - WITH VACUREMA®

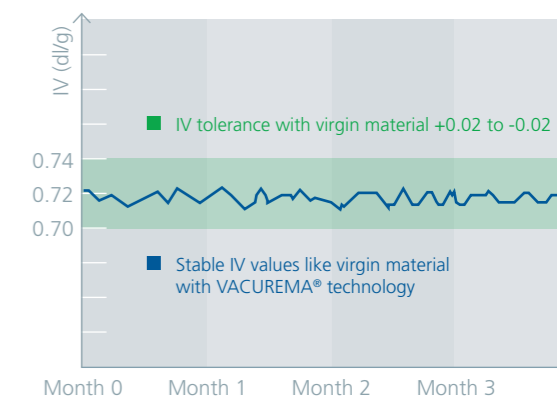

Looking good! Safe to say.

Bottles and thermoforming products which are produced using rPET melt from a VACUREMA® stand out through their flawless appearance. **The key to success here is: highly efficient ultrafine filtration.** Even if the material has been thoroughly washed, post-consumer PET flakes contain approx. 20 ppm aluminium and steel particles. In the case of a plant with output at 1,000 kg/h (24 tonnes/day) this already corresponds to 480 grams of aluminium and steel a day!

THE PROBLEM: if such impurities are not removed from the melt, surface defects may occur in the preforms and bottles plus sheet and thermoforming products which can lead to the end product bursting.

THE REQUIREMENTS: robust extrusion in combination with high-performance ultrafine filtration (e.g. 32 or 64 µm screen mesh size).

THE SOLUTION: VACUREMA® inline systems are designed precisely for this, with the stable extrusion unit featuring the highly efficient EREMA SW-RTF® filter.



The highly efficient ultrafine filtration of the PET melt is one of the key strengths of VACUREMA® technology.

CLEAN MELT
CLEAN PERFORMANCE
LARGE AREA ULTRAFINE FILTRATION



Flakes from cooking oil bottles? No problem.

If a high amount of the PET flakes comes from cooking oil bottles this means much higher maintenance for PET recycling systems, which often raises the question of whether the processing is worthwhile. The VACUREMA® system offers an ideal solution here: the optional condensate separator enables you to process such cooking oil PET flakes very efficiently with minimum maintenance and maximum profitability.

PERFECT COLOUR. PERFECT APPEARANCE.

VACUREMA® technology handles your valuable PET material with great care and ensures that it has the lowest possible stress and discolouration. You are left with a result to be proud of: **products with top and stable colour values – on a par with virgin material in terms of shape and colour!**

Several aspects are responsible for this very good colour finish: the melting of the PET material takes place under vacuum, the extruder is relatively short and the entire duration of the process from flake to finished product is – compared to other solutions – extremely short.

The EREMA SW-RTF® filter is:

- **Highly effective:** the filter removes even the smallest of aluminium, steel and other particles from the melt.
- **Material-friendly:** thanks to large active filter areas the system ensures that stress on the polymer is minimised – a crucial measure to avoid black spots in the end product.
- **Labour-saving:** fully automatic filtration without production interruption thanks to self-cleaning through partial area backflushing.
- **High performance:** extremely low pressure losses despite very fine filtration, high filtration capacity and long filter service life.

Flexibility wins.

Flexibility is the ability to adapt perfectly to changing conditions. Flexibility is: VACUREMA®. Because, unlike all other PET recycling systems, VACUREMA® turns widely varying input into a very stable, exactly defined output.

Flexible on input

Flexibility with the input material means for you: with VACUREMA® it is possible to combine an extremely wide variety of PET material types/shapes with each other. The mixing ratio of the materials can vary. The input material can likewise vary enormously in terms of moisture, degree of contamination and IV values.

VACUREMA® - efficient processing of:

- PET bottle flakes
- Ground amorphous skeleton waste or edge trim
- Strapping production waste
- Virgin material
- Plus mixtures with bulk densities from 250 to 850 kg/m³

The EREMA system also has moisture fluctuations under perfect control. These play an important role in day-to-day production, for example when the flakes come from different (external) material streams. Storage also has an effect on moisture, as a result of condensation in material silos, for example (especially in spring and autumn) or outdoor big bag storage areas.



Stable on output

VACUREMA® evens out these fluctuations in the input material and uses it to produce a stable, clean and high-quality rPET melt. This flows back directly into the downstream unit which produces the respective end product – such as sheet, preforms, strapping or fibres.

Thanks to the patented vacuum pretreatment at elevated temperature it achieves high and stable IV values and top colour results despite varying moisture levels and different IV values in the input material. Plus it comes with maximum process stability.

Extremely varying input

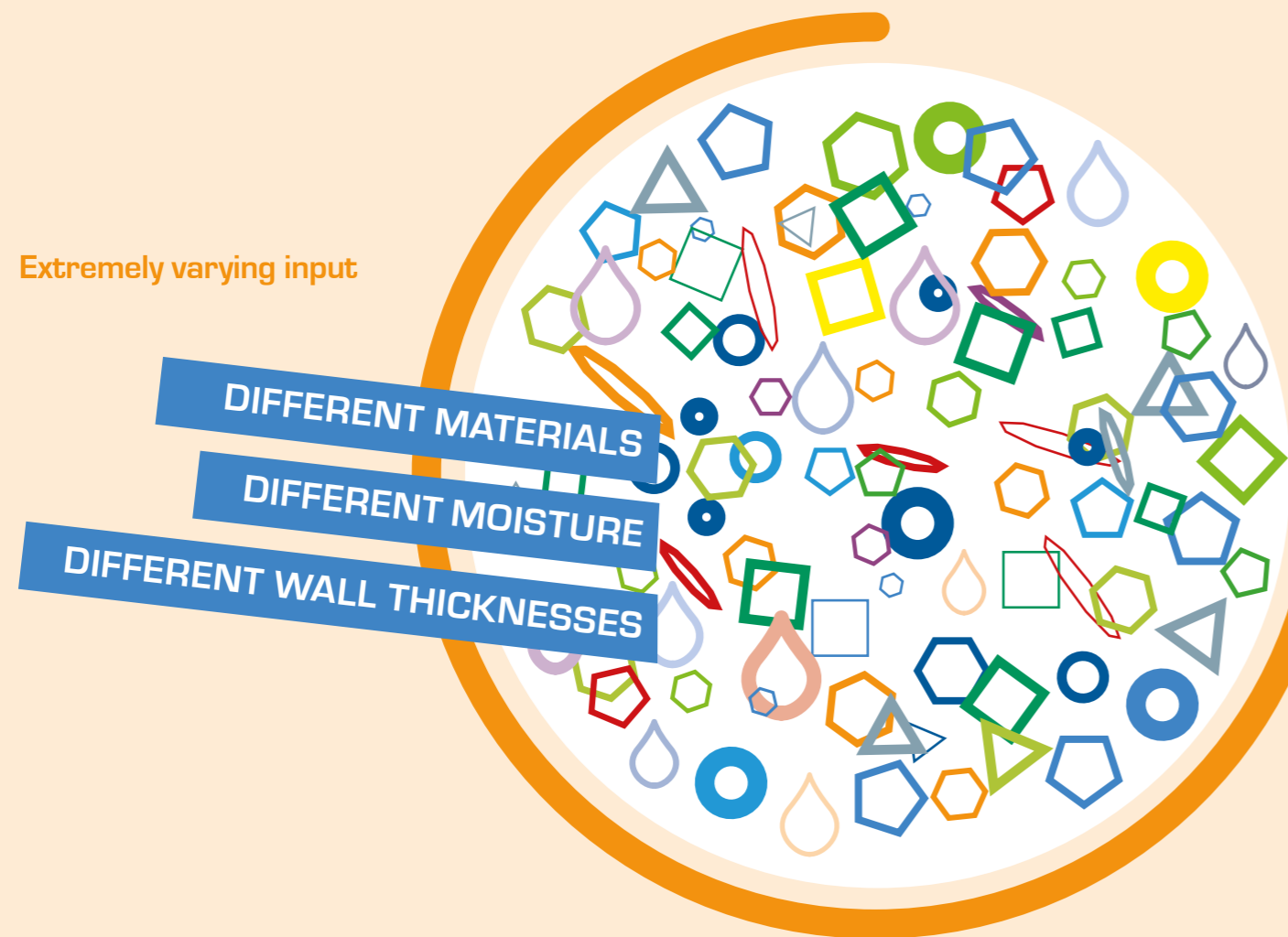

Output:

- Stable IV values
- Top colour results



VACUREMA®

Sustainably better.

Conserving resources.

This central idea is one of the key driving forces in PET recycling. This is because both the environment and the public benefit equally when waste is avoided and used PET products are transformed into new ones.

Conserving resources.

This also has to be a guiding principle for the technical process of rPET sheet or strapping production. Because if you bear in mind that electrical energy accounts for roughly 30 per cent of the costs in this area, those technologies which address this specific issue have a clear edge.

Conserving resources.

VACUREMA® Inline technology fulfils this requirement in every respect. Thanks to its basic principle, VACUREMA® is programmed through and through for energy efficiency and saving both water and space. This includes the multifunctionality of the vacuum reactor which unites many required working steps in an energy-saving and compact way in one unit, the short extruder without degassing and a host of other ecological measures.

This efficiency is enhanced even further in perfect unison with the directly following production line. Because thanks to the inline processing of the PET melt, no detour has to be made via pellet production, which would otherwise be necessary. A significant energy-saving benefit which reduces your energy costs considerably.

SAVE ENERGY
REDUCE CO₂

SAVE WATER
SAVE COSTS
SAVE SPACE

VACUREMA® ENERGY-SAVING CHAMPION

Saving energy means saving costs.

High performance yet still highly energy efficient. This is the challenging performance profile of modern PET processing systems. VACUREMA® Inline technology masters this challenge to perfection and in doing so sets the standard for energy efficiency in the marketplace. Not only the environment but also you benefit. Because if you reduce energy consumption, you likewise reduce production costs considerably. **Hour after hour.**

1ST PLACE FOR VACUREMA®

Green light for everything thanks to top energy efficiency!

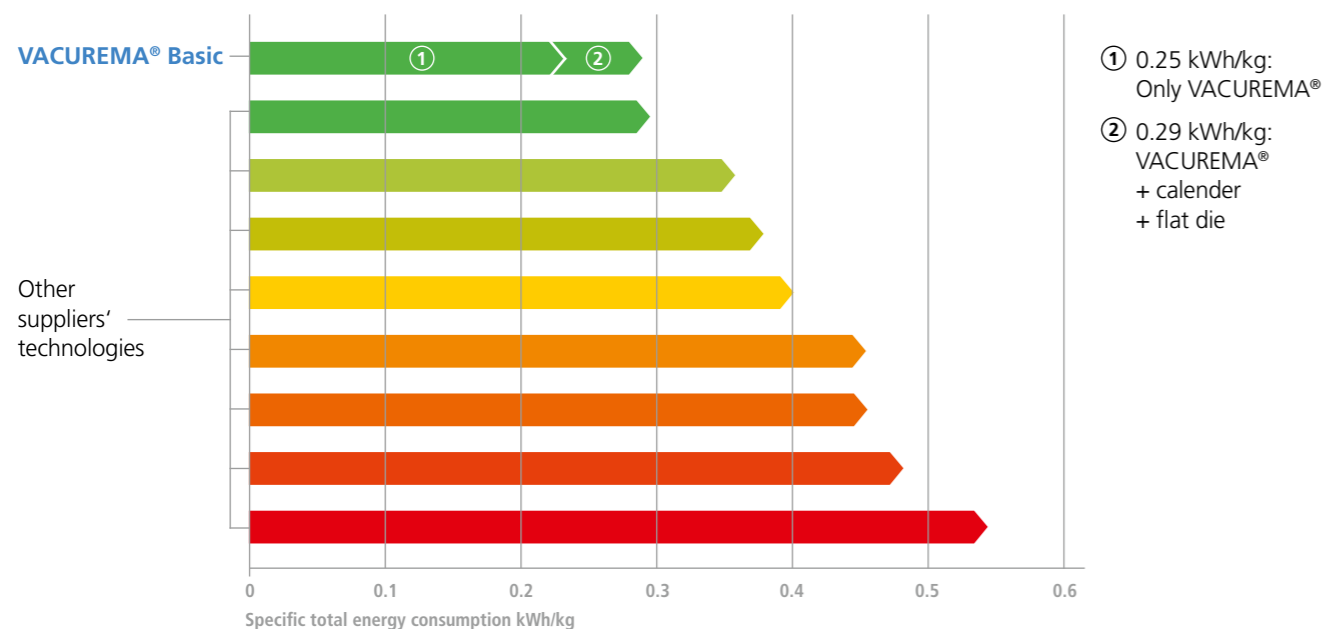

Only 0.29 kWh/kg* – this is how low the specific total energy consumption of the VACUREMA® Inline Sheet system is. This leading position in terms of energy efficiency was achieved in impressive style by the EREMA system in a comparison with eight other PET recycling technologies. The results were confirmed by an independent testing institute. The VACUREMA® system is located at a major client's facility in Germany and produces food contact compliant thermoforming sheet.

VACUREMA®. Saving energy the intelligent way.
The comparison shows you are safe and sound.

* Source: SKZ – Das Kunststoff-Zentrum, specific total energy consumption measured at 0.29 kWh/kg including calender and flat die

The basis for energy efficiency: the basic VACUREMA® principle

The basic VACUREMA® principle means dramatic savings in the energy consumption of the entire process compared to conventional solutions. Because thanks to its multifunctionality, the vacuum reactor handles a multitude of necessary processing steps such as predrying, decontamination and IV increase in a very compact unit and a very energy-saving way. Another energy benefit: VACUREMA® technology enables you to use a relatively short extruder which does not require any additional degassing.

With conventional systems, on the other hand, energy consumption is considerably higher because separate and energy-intensive predrying and crystallisation units are required and the extruder is also longer and features degassing.

No additional predrying necessary

Thanks to the multifunctionality of the vacuum reactors the PET input material is not only decontaminated, compacted, buffered and dosed inside them, it is also automatically heated and predried. The benefit: additional predrying is not necessary. With the standard design, materials with input moisture of up to 1% can be processed (even up to 1.5% as a special option).

Needs less. Gives you more. ecoSAVE®

VACUREMA® systems conserve your resources: thanks to ecoSAVE® technology with up to 12% less energy consumption, reduced CO₂ emissions and lower production costs. ecoSAVE®, standard on all systems, is a complete package of design and process engineering measures which increase energy efficiency. High-quality, energy-saving components such as high-performance motors, for example, and very robust insulation material in the pelletising section are used especially for this purpose.

VACUREMA® saves water

The utility-free vacuum pump (optional) requires no water to create the vacuum. As a result, you save not only operating but also maintenance costs. Compared to other pump systems, you can achieve considerable cost benefits after just one year.

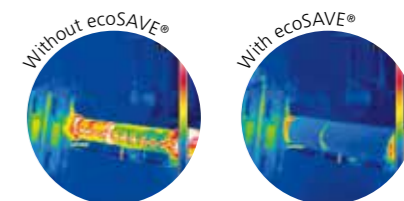

VACUREMA® Inline Sheet

Fully food contact compliant. Energy efficiency included.

100% food contact compliant. Through and through. rPET sheet which comes out of a VACUREMA® Inline Sheet system is ready for direct food contact. It fulfils the high requirements placed on it by the subsequent thermoforming process. In other words: top mechanical properties. The sheet also stands out through its flawless appearance. Because it achieves top colour results and, thanks to large-area ultrafine filtration, is free from contaminants. **Decisive arguments in direct food contact.** So the customer too can make the right choice of finished product in the supermarket.

With the high-performance VACUREMA® Inline Sheet system you produce this **top-quality sheet in a very cost-effective and energy-saving way.** The system turns your post-consumer or inhouse PET material into the final product – rPET sheet – highly efficiently and in a single process step. No detour via pellet production is required. Additionally, the proven VACUREMA® extrusion system is combined with an appropriate downstream flat sheet system from leading manufacturers.

Energy-saving champion VACUREMA®

With only 0.25 kWh/kg* specific total energy consumption, the VACUREMA® Inline Sheet system leads the field in terms of energy efficiency. This was confirmed in an independent test in which the energy consumption of ten PET recycling technologies was measured. See page 18 for more details.

Flexible on input

One of the central benefits of VACUREMA® technology: you stay **highly flexible regarding input, while your output remains completely stable.** This is because you can produce the food contact compliant rPET sheet either directly from 100% washed post-consumer PET bottle flakes or 100% from inhouse waste edge trim. Or from the different mixtures of these input materials, including ground amorphous skeleton waste or also virgin material. With VACUREMA® you process different bulk densities from 250 to 850 kg/m³. And: in terms of moisture, it is no problem either for the technology if your input material fluctuates. Thanks to the constant and high IV values, which are also realised with poorer quality input materials, consistently high operational stability is also ensured.

Taking the lead in sheet. VACUREMA®.

*VACUREMA® only – without calender and flat die



Benefits

- **Everything in one working step:** Directly from PCR-PET flakes to 100% rPET sheet
- **100% food contact compliant rPET sheet**
- **Top quality:** sheet with best mechanical properties for thermoforming
- **Constant and high IV value** even with poorer quality input materials.
- **Excellent homogenisation** combined with **short extruder** (very material-friendly)
- **High profitability**
- **1st place in energy efficiency:** Extremely low total specific energy consumption, only 0.25 kWh/kg* No additional material predrying necessary
- **Maximum flexibility:** wide range of PET input mixtures possible
- **Inhouse benefit:** 100% edge trim and skeleton waste can be processed
- **Robust single-screw extruder:** long service life and reduced maintenance costs
- **Overall system competence at its finest:** VACUREMA® in combination with leading sheet plants: Amut, Battenfeld-Cincinnati, Diamat Maschinenbau, Kuhne, SML, Welex

* Source: SKZ – Das Kunststoff-Zentrum, specific total energy consumption measured at 0.25 kWh/kg without calender and flat die

Cooperation partners



VACUREMA® Inline Sheet

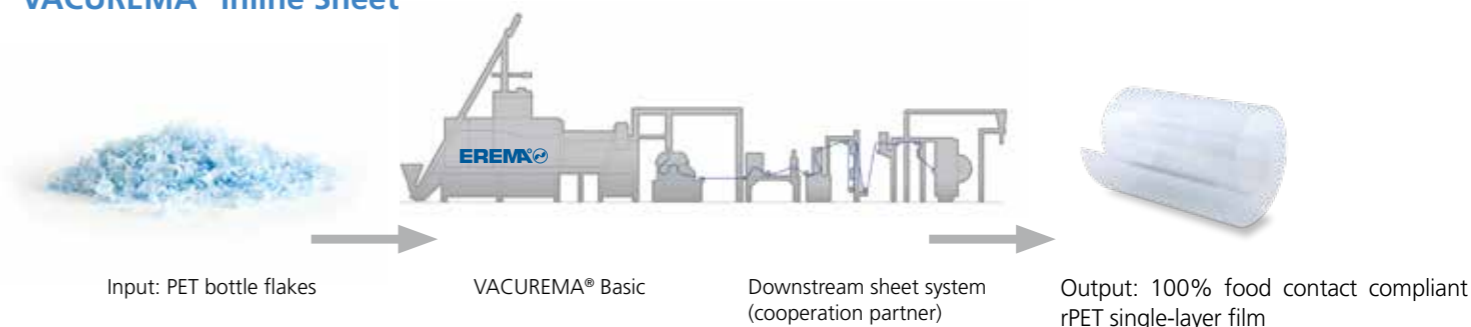

Food contact compliant monolayer sheet

rPET sheet produced using VACUREMA® technology has a decisive advantage over conventional ABA multilayer sheet: it is food contact compliant through and through and can thus be designed as a pure monolayer sheet. **A costly A level with virgin material is not necessary.**

VACUREMA®: food contact compliance benefits even with ABA multilayer sheet

In some cases ABA multilayer sheet is chosen deliberately instead of monolayer sheet – for example because the application requires the use of colour/antiblock additives and the ABA structure of the sheet helps to save production costs. This is because the additives are usually used only in the two A layers and the middle layer (B) remains free from these – very often costly – additives.

With regard to food contact compliance, however, this ABA structure is problematical if the middle layer (B) does not consist of food contact grade rPET. The reason, according to a study published recently by Fraunhofer Institute*, this structure has no effective barrier layer.

In order to achieve thorough food contact compliance, therefore, **the middle layer (B) also has to be food contact compliant. This is possible with VACUREMA®.**

* Paper: "Assessment of Recyclates Behind Functional Barriers", Fraunhofer Institute for Process Engineering and Packaging (IVV), PET Recycling for Food Contact Conference, 3 March 2016, Frankfurt, Germany



INPUT

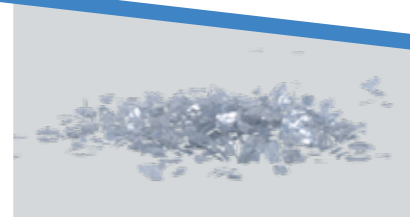

50% washed PET flakes

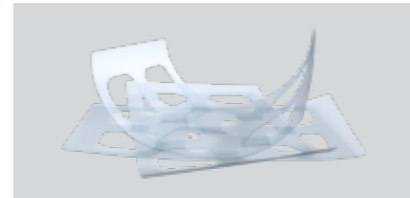

40% skeleton waste from thermoforming



10% sheet production waste and edge trim

IV champion VACUREMA® Stable IV. Even after numerous recycling loops.

VACUREMA® gives you a very constant and high IV value. This is also shown by a comparison with a conventional twin/multiple-screw system, as the IV performance of VACUREMA® is considerably stronger. With a typical input material mixing ratio of 50% washed PET flakes, 40% skeleton waste and 10% production sheet waste and edge trim, the EREMA technology is above the critical IV value mark of 0.7 dl/g even after many reprocessing cycles. And, despite the fact that the input material with the same mixture composition by nature always has a lower input IV value. The twin-screw system lies well below the IV threshold of 0.7 dl/g here. The thicker the rPET sheet, the greater the importance of this IV benefit with VACUREMA®, because this makes the thermoforming product stronger.

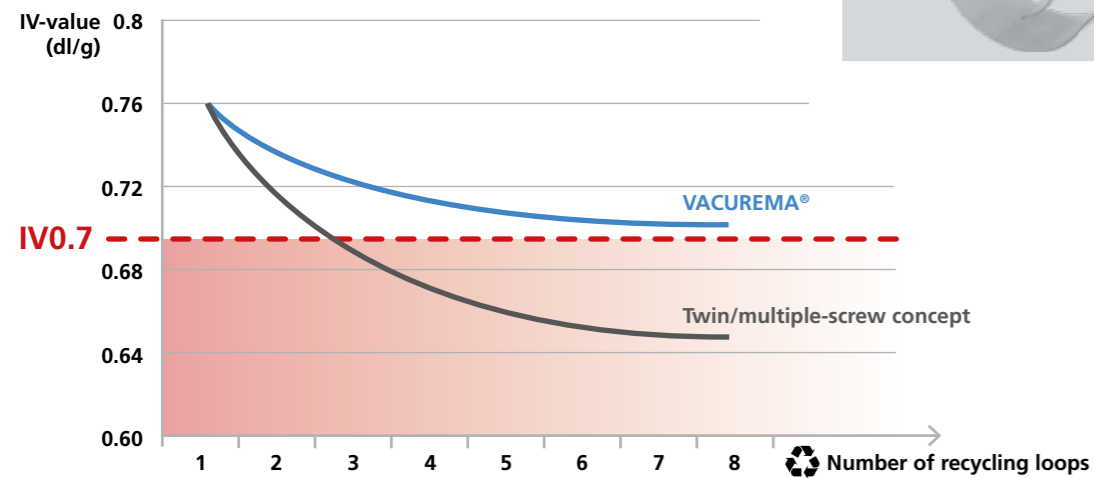

Tony Mitchell, Kobush/COVERIS UK Sales Director

“ The new EREMA system with SML downstream equipment enables us to continue to increase the amount of post-consumer waste in our rPET production without sacrificing any quality in clarity in the thermoforming process. ”

MPR®

The perfect addition for your existing extrusion

From contaminated, moist flakes to clean, dry, dust-free, crystallised and food contact compliant flakes. This is the job of the Multi Purpose Reactor (MPR®) from EREMA. And the system takes care of this for you in an extremely reliable and energy-efficient way.

The Multi Purpose Reactor complements your existing extrusion system and ensures that your washed PET material is already food contact compliant prior to extrusion. In many countries the legal framework will continue to develop in this direction; in the EU it is already laid down in Commission* Regulation (EC) No. 282/2008.

However, you can also use the MPR® as a stand-alone solution (without subsequent extrusion).

Flexible on input

The patented MPR® is a highly efficient crystallisation dryer, as also used (in a somewhat different form) in the VACUREMA® system. Washed PET bottle flakes, ground PET flat sheet waste and virgin PET material plus mixtures of them can be used as input material.

* Commission Regulation (EC) No. 282/2008 of 27 March 2008 on recycled plastic materials and articles intended to come into contact with foods.

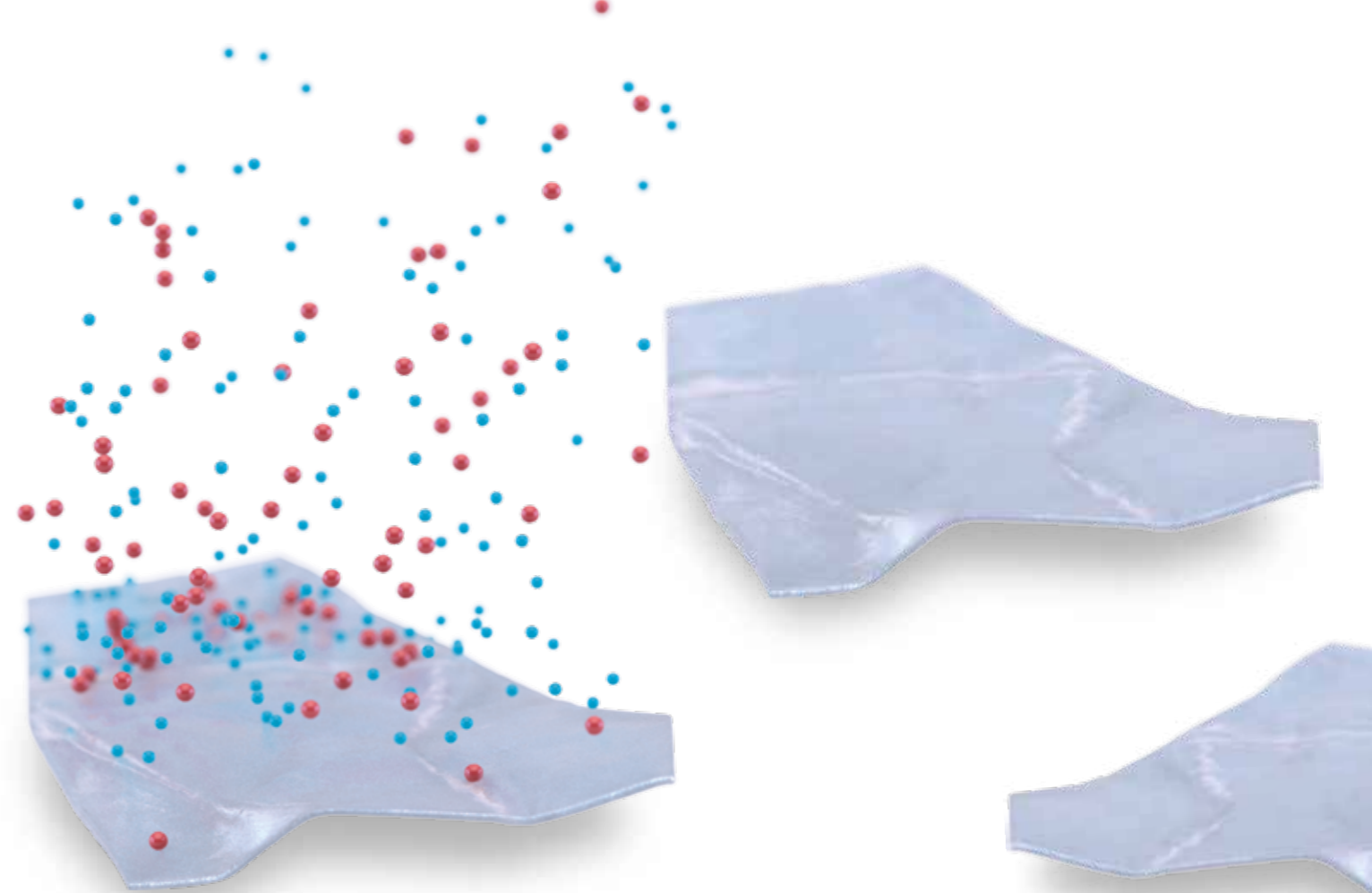
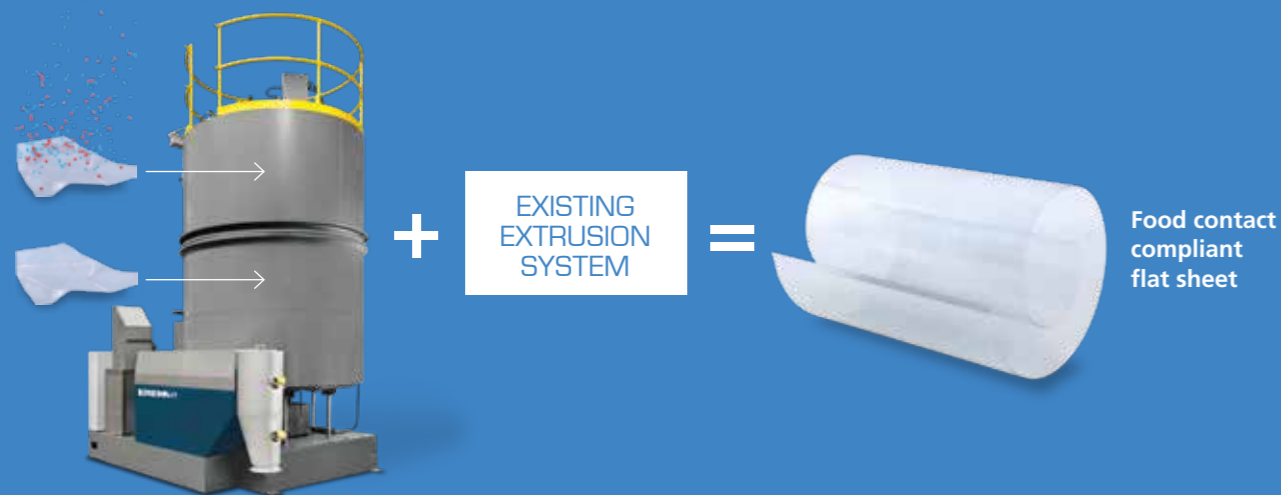

Efficiency benefit: the MPR® system makes use of the advantageous surface-to-volume ratio which the PET material has in flake form. This means that the decontamination and drying of the material takes place very efficiently.

BENEFITS

- The system gives you clean, dry, dust-free, crystallised and **food contact compliant** PET flakes already **BEFORE your existing extrusion**
- **Easy to retrofit** on your existing extrusion plant
- **High profitability**
- **Best energy efficiency:**
Extremely low total specific energy consumption of only 0.1 kWh/kg
Comes with energy-efficient ecoSAVE® technology
- **Maximum flexibility:** wide range of PET input mixtures possible, input materials with varying residual moisture and bulk density possible
- **More output:** thanks to the bulk density increase of up to 80% possible for PET flakes and flat sheet waste the output of your PET extrusion plant increases, too
- **Technical benefits:**
Increased temperature and for **effective decontamination**, drying and crystallisation of PET
Better flake colour results thanks to vacuum processing
Dust-free flakes to avoid gelling problems
Materials with a low melting point can be processed without bridge formation (e.g. PET/PE, PLA, PET-G)
- Predrying to **below 50 ppm moisture**
- Slight increase of IV value possible

Pure PREformance!

The innovative VACUREMA® Inline Preform technology.

The innovative VACUREMA® Inline Preform system makes it possible: for the first time you can produce food contact compliant 100% rPET preforms directly from post-consumer PET flakes. In one process step – without the detour via pellet production. That's efficiency! And this gives you clear benefits. This is how you can achieve considerable savings in energy consumption, reduce your logistics and process costs and increase profitability and productivity in your preform production process.

Innovation through cooperation

Thanks to intensive research and development collaboration the two leading companies for efficient PET solutions – EREMA and SIPA – have been able to launch this groundbreaking innovation. The new inline preform system combines the efficiency benefits of the proven VACUREMA® technology with the innovative XTREME preform production system of SIPA. By combining injection and compression techniques this system allows you to produce preforms that are up to 10% lighter than even the lightest injection molded preforms – but without losing any key properties.

High energy efficiency saves costs

The inline preform system is programmed through and through to save energy. Each system, VACUREMA® and XTREME, stands out through extremely energy-efficient performance. And this ingenious combination of the two technologies increases this efficiency even further, as a comprehensive process is created in which the melt flows „at one heat level“ and no intermediate cooling step is required. A process which saves you considerable energy costs and achieves top colour results.

BENEFITS

- **Everything in one working step:**
Directly from PCR-PET flakes to 100% rPET preforms
- **100% food contact compliant rPET preforms**
- **Top quality:** preforms with best mechanical properties for the stretch blow process
- **Constant and high IV value** even with poorer quality input materials
- **Top colour results**
- **High profitability**
- **Top energy efficiency:**
Low specific total energy consumption
No additional material predrying necessary
- **Robust single-screw extruder:**
long service life and reduced maintenance costs
- **Top-class full system competence:**
VACUREMA® in combination with the XTREME preform production system of SIPA

Cooperation partner



WORLD FIRST!

From PCR-PET flakes to food contact grade 100% rPET preforms directly for the first time

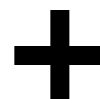
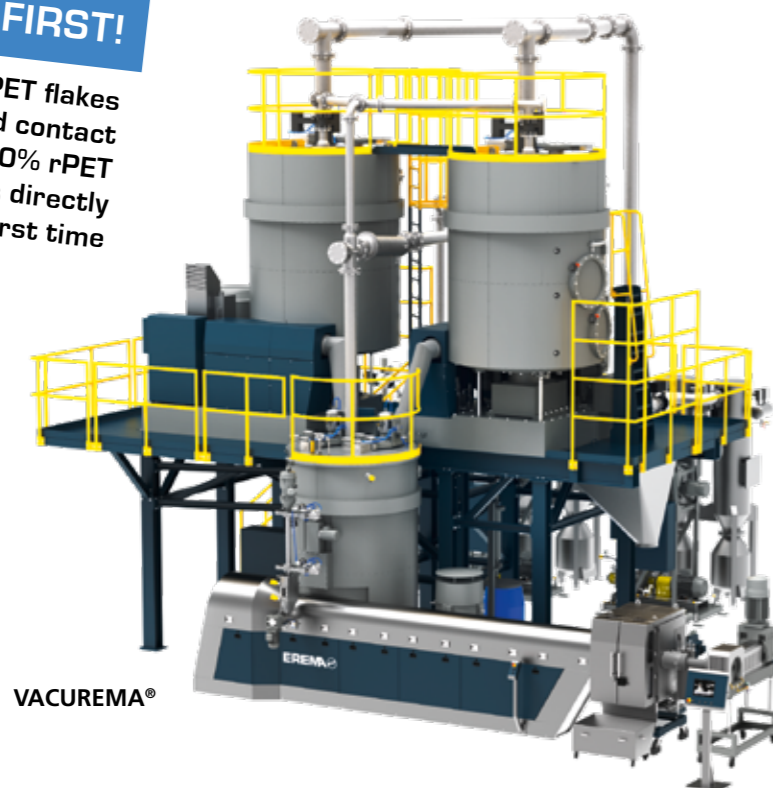

Less weight. More freedom in design. XTREME.

Preforms with up to 10% less weight – this is what the innovative XTREME system from SIPA gives you with rotary injection-compression technology. XTREME realises this remarkable reduction in weight in comparison with the lightest of injection molded preforms – without losing any key properties. Another bonus of the SIPA process: more freedom of design. This is how you can realise completely new and unique preform designs.

XTREME: profitability

- Lowest preform cost
- Preforms up to 10% lighter compared to traditional injection systems
- Minimised running costs thanks to lower energy consumption, lower transportation costs and less waste production

XTREME: performance and flexibility

- Strong competence in preform extreme lightweighting and complex applications
- Reduced material stress and AA due to lower injection pressure
- Innovative preform design with almost no limitations in thickness (L/t up to 80)
- Consistent preform weight
- Simultaneous production of two different preforms which can be sorted into different bins
- Inline preform inspection system controls preform quality (optional)
- Preform weight mechanically adjustable on the machine without stack change

XTREME: output and efficiency

- Increased output thanks to cycle time reduced to 5s
- Changeover time: 1 hour for 96-cavity mold and 45 minutes for a 72-cavity mold
- Significantly reduced footprint: less than 35 m²
- Easy maintenance: cam-driven synchronism prevents operator error
- Totally oil-free
- Reduced carbon footprint



VACUREMA® Inline Strapping



More safety, higher quality and better handling – these are the benefits of PET strapping compared to steel strapping. And with the high-performance VACUREMA® Inline Strapping system you can produce this strapping **very inexpensively and in top quality while saving energy**. Because it turns your post-consumer PET bottle flakes directly into high-strength strapping without any further pretreatment.

The VACUREMA® extrusion system is combined here with an appropriate downstream production line. This comes from the leading manufacturers Reimotec (Reifenhäuser Group) or SIMA (Dietze + Schell Group). This is how your **end product is created very efficiently in a single process step** – without the detour via pellet production.

Top energy efficiency

The overall energy consumption of the compact VACUREMA® strapping technology is unrivalled at 0.65 kWh/kg. Thanks to the constant and high IV values, which are also achieved with poorer quality input materials, consistently high operational stability is also ensured. Another quality bonus: the stable and very tight molecular weight distribution makes sure that the **strapping has the required mechanical strength**.

Flexible on input

You can produce the high-quality PET strapping directly from 100% washed post-consumer PET bottle flakes. Or: you mix the flakes with waste production strapping or virgin material – bulk densities from 250 to 850 kg/m³ are possible. The benefit: you are **highly flexible regarding input, while your output remains completely stable**.

Tight distribution, stable quality

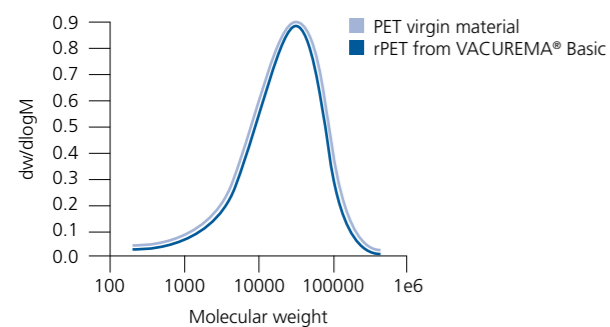

The molecular mass distribution graph shows the benefit of VACUREMA® quite clearly. The narrow distribution means high tensile strength and high resistance to splicing – a strong quality bonus for the strapping.

Endless benefits

- **Everything in one working step:** Directly from PCR-PET flakes to 100% rPET strapping
- **Top quality:** extremely durable, high-strength strapping
- **Constant and high IV value** even with poorer quality input materials
- **High profitability**
- **Top energy efficiency:** Extremely low total specific energy consumption of only 0.65 kWh/kg
- **Maximum flexibility:** large range of PET input mixtures possible
- **Top-class full system competence:** VACUREMA® in combination with Reimotec (Reifenhäuser Group) or SIMA (Dietze + Schell Group)

Cooperation partners



BETTER SOLUTION.
BETTER DIRECT.



VACUREMA® Inline Strapping

The entire process in detail.



The upstream process: VACUREMA® technology

The proven energy-saving and compact VACUREMA® technology consists of a vacuum reactor and a directly linked single-screw extruder. An expensive, conventional predryer/crystallisation/extruder system is not required. This means that **you save up to one third of the total specific energy costs.**

One of the key benefits of the patented VACUREMA® technology is that both residual moisture and other harmful chemical contaminants which promote IV loss are already removed BEFORE extrusion. This decisive quality bonus, in combination with the fine melt filtration leads to very strong strapping with very low cross sections. **In short: top quality through top technology.**

The disadvantage of conventional systems

With many traditional systems, residual moisture and contamination are not removed until AFTER the melting process in the extruder degassing section. By this time, however, the moisture and chemical impurities which have entered the extruder have already done their damage as fluctuating moisture content in the extruder melting zone causes fluctuating IV in the melt and – even worse – in the product. The same applies to the contamination variations of many volatile, residual chemical contaminants in the input material. This results in undesired negative effects, especially in the case of cheaper, poorer quality input materials, including not only inconsistent or low strength of the strapping produced but also and above all, less stable production conditions at the production system.

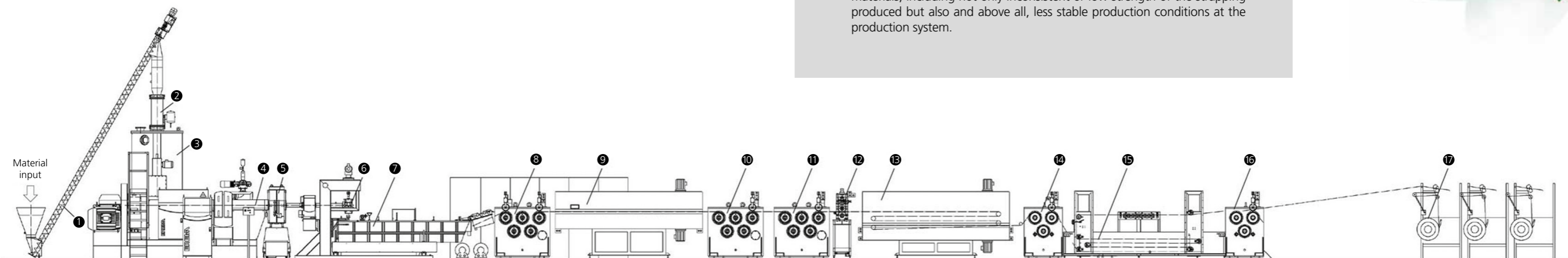

VACUREMA® Basic

Extrusion process

- ① Conveyor screw (feeding)
- ② Vacuum sluice
- ③ Vacuum reactor
- ④ Single-screw extruder
- ⑤ Large area ultrafine filtration with fully automatic, self-cleaning EREMA melt filter system

Strapping process

- ⑥ Melt pump
- ⑦ Cooling bath
- ⑧ Slow godet
- ⑨ Stretching oven
- ⑩ First fast godet
- ⑪ Second fast godet
- ⑫ Embosser
- ⑬ Stabilisation oven
- ⑭ Stabilisation godet
- ⑮ Water cooling bath
- ⑯ Second stabilisation godet
- ⑰ Winder

The downstream process: strapping technology from

- SIMA (Dietze + Schell Group) or
- Reimotec (Reifenhäuser Group)

The strapping system receives the melt directly from the VACUREMA® system. The material is routed to the extrusion head via double spin pumps, then to the channels of the extrusion die and scaled to size as required. Next, the material passes through several stages of thermal treatment, stretching, embossing, stabilising, cooling and winding. The **end product stands out through excellent dimensional stability and first-class mechanical properties.**



VACUREMA® Inline Fibre

Strong fibres. Strong benefits.

Whether it is rPET carpet fibres or staple fibres: thanks to the versatile VACUREMA® technology in combination with the right downstream equipment, you can produce the end products in an extremely energy-efficient and profitable way in just one working step – directly from 100% washed post-consumer PET bottle flakes or mixtures of these flakes with virgin material.

rPET carpet yarns Trützschler Switzerland

The purity of the recycle thanks to the large-area ultrafine VACUREMA® filtration paves the way in the spinning of BCF (Bulked Continuous Filament) yarns for high-quality filaments. As the PET material is particularly temperature-sensitive, **constant pressure conditions** must prevail when processing. The VACUREMA® system fulfils this requirements: it scarcely influences the spinning process as only minimal fluctuations in pressure occur when backflushing or changing over screens.

TRÜTZSCHLER MAN-MADE FIBERS

VACUREMA® partner for rPET carpet yarns

Trützschler Switzerland is your specialist for the filament extrusion of thermoplastic polymers such as PP, PA6, PA6.6 and PET (primary pellets) and rPET. The company supplies bespoke solutions for the production of carpet yarns and high-strength/low-shrink filaments for industrial applications. One particular feature of all concepts is the symmetry: every spinning position is geometrically equal so the melt is distributed homogeneously and every bundle of filaments has exactly the same treatment. The machines can be precisely configured for small batches and frequent colour changes or to large plants for standard grades and minimum processing costs. Key components such as the frictionless HPC texturing unit enable the production of premium yarn grades with unique crimping characteristics.

BCF yarns from symTText systems fulfil a wide variety of requirements:

- Mono-colour yarns for woven and tufted carpets
- Tri-colour yarns for tufted carpets
- Coarse yarns up to 5,000 denier
- Fine yarns down to 400 denier
- Spun-dyed qualities for automotive and other applications

BENEFITS

- **Everything in one working step:** Directly from PCR-PET flakes to 100% rPET fibre
- **Top quality:** extremely tough, high-strength fibres, high crimp
- **Constant and high IV value** even with poorer quality input materials
- **High profitability**
- **Top energy efficiency**
- **Maximum flexibility:** large range of PET input mixtures possible



Stapel fibre production

Technical data

IV values attainable in the melt / flake – variable according to chosen throughput
IV increase according to plant type and set throughput; example based on VACUREMA 2018 T:

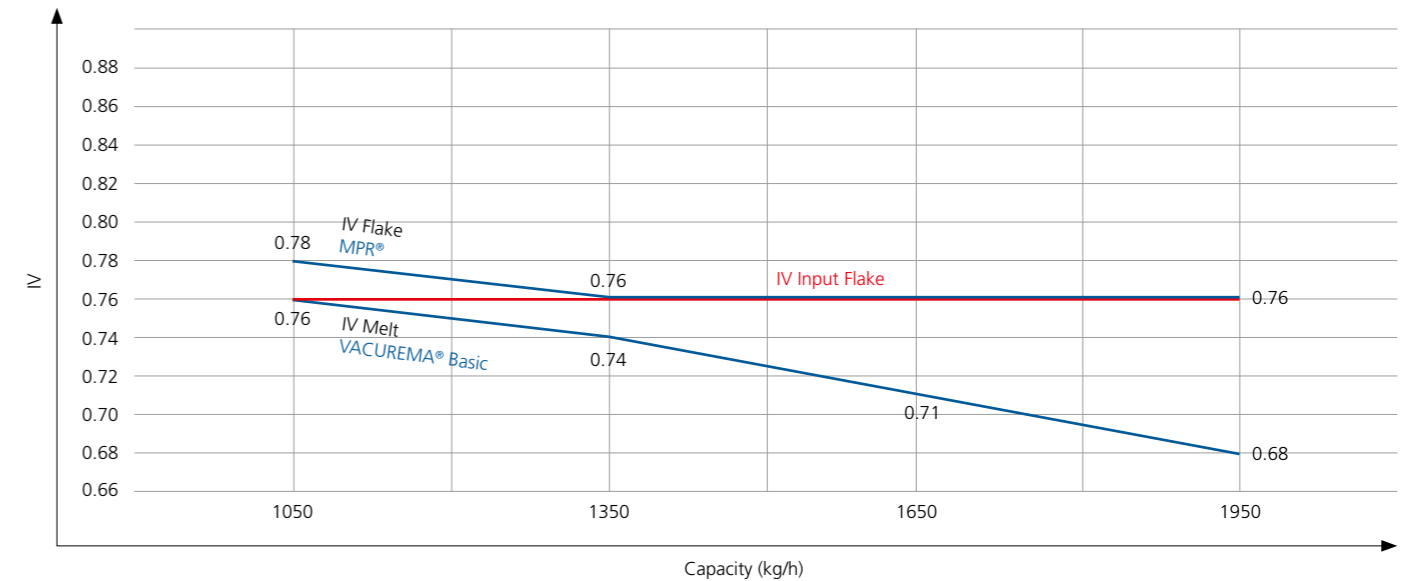

Technical data VACUREMA® PET extrusion systems

Systems available	Capacity	
VACUREMA Basic 1310 T	400 kg/h	600 kg/h
VACUREMA Basic 1512 T	600 kg/h	900 kg/h
VACUREMA Basic 1714 T	850 kg/h	1000 kg/h
VACUREMA Basic 1716 T	1100 kg/h	1450 kg/h
VACUREMA Basic 2018 T	1350 kg/h	2000 kg/h
VACUREMA Basic 2021 T	1800 kg/h	2600 kg/h
VACUREMA Basic 2321 T	2000 kg/h	2900 kg/h
VACUREMA Basic 2625 T	2500 kg/h	3300 kg/h
VACUREMA Basic 2628 T	3000 kg/h	4000 kg/h

Downstream process: system sizes and output capacities on request

Technical data MPR®

Type	Average output capacity in kg/h	
	max.	
MPR 1500	900	
MPR 1700	1,500	
MPR 2000	2,000	

Headquarters & Production Facilities

EREMA Engineering Recycling
Maschinen und Anlagen Ges.m.b.H.
Unterfeldstrasse 3 / 4052 Ansfelden / Austria
Phone: +43 (0)732/31 90-0
erema@erema.at / www.erema.com

**For worldwide subsidiaries and
representatives please visit
www.erema.com**

Subject to technical modifications.
© EREMA Engineering Recycling Maschinen
und Anlagen Ges.m.b.H.



08/24

[https://www.erema.com/en/
download_center/](https://www.erema.com/en/download_center/)